

Data Sheet



Article number: 20343160M12KSE

Description: E+G levelling foot
GN 343.1-60-M12-KSE

Measures

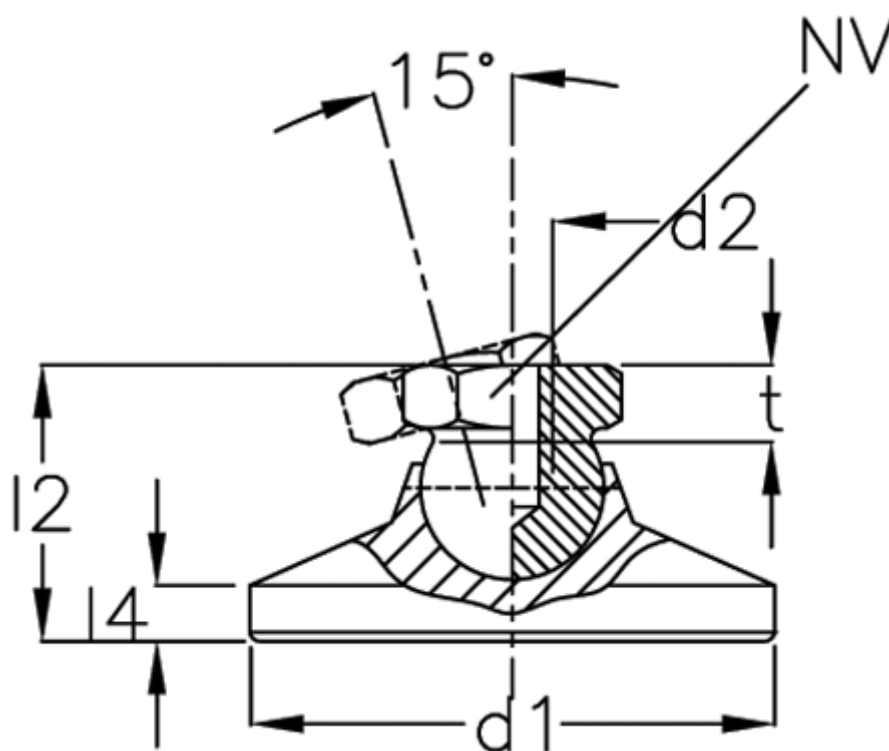

d1	= 60
d2	= 12
l2	= -
l4	= -
NV	= 17
Static load (kN)	= 33
t min	= 11.5